

Horizon

Folder Options

AF-76 Series / AFC-74 Series / AFC-56 Series / AF-406 Series

**Superior fold
with extensive optional devices**

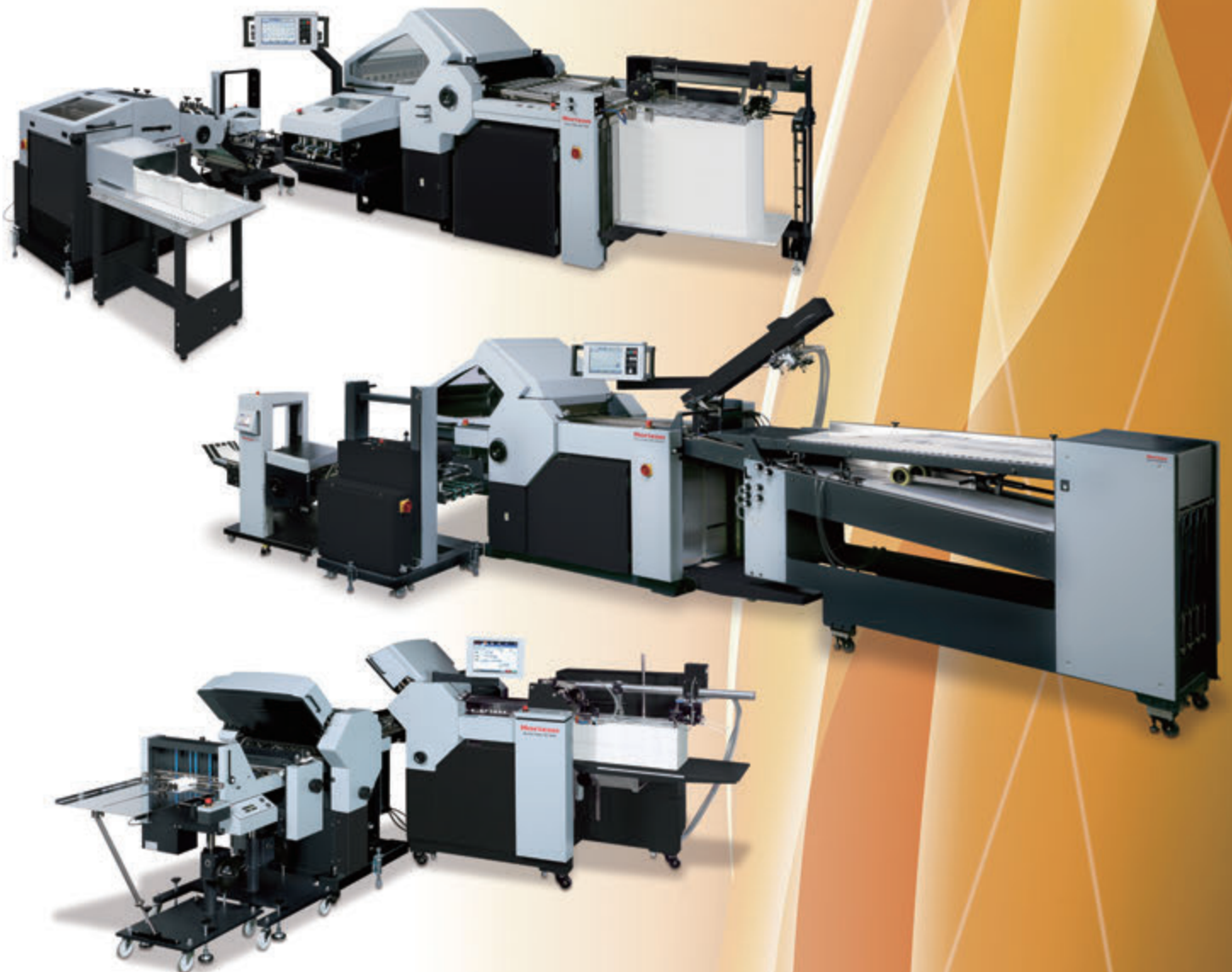

AF-76 Series / AFC-74 Series

SD-74F / SD-74R / SD-74P Supersonic Detector

Optional supersonic detector is available for double feed detection. This detects space between sheets for accurate double feed detection even with a solid black printed sheet.

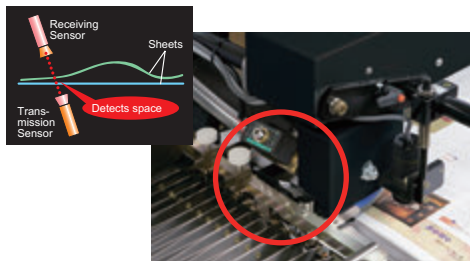
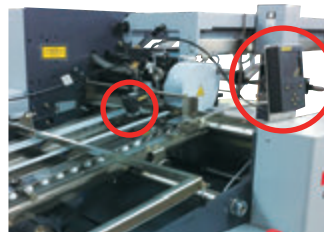

Image Checker

The camera checks the printed sheets to prevent errors such as sheet loading error and printing error.



CGU-50 Gluing Unit

The gluing unit can produce 8-page or 12-page glued booklets and direct mail applications.

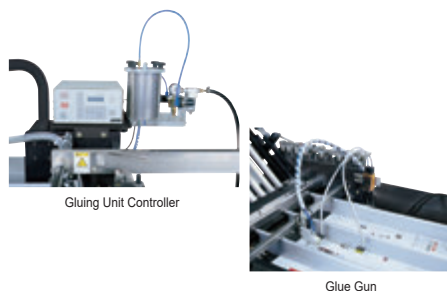

FP-74 (FSP-74) Front Perforation Unit

This unit permits perforating before folding. A hardened blade drum provides for high precision micro perforation. Skip perforation unit (FSP-74) is also available.



AF-ST6 Strip Trim Device

Strip trimming after the parallel fold section can be performed using slitters for multiple-up jobs. Stripped width can be adjusted. (3 mm to 10 mm at 1 mm intervals)

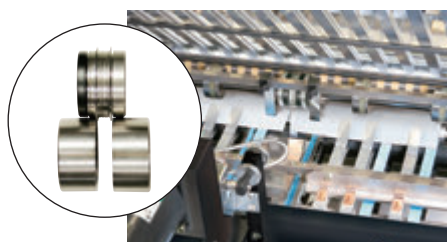

KT-ST6 Strip Trim Device below 1st Knife

Strip trimming in the cross fold section can be performed using slitters for multiple-up jobs. Stripped width can be adjusted. (3 mm to 10 mm at 1 mm intervals)



KT-ET6 Edge Trim Device below 1st Knife

Segmented rollers below the 1st knife are provided as standard. Simply attach the KT-ET6 to trim the open/closed side of glued signatures to complete the booklet (8 page, 12 page).



GFB-74 / GFB-76 Gate Fold Buckle

The gate fold buckle can be set up quickly, with no special skill for precise, accurate closed-gate folding.

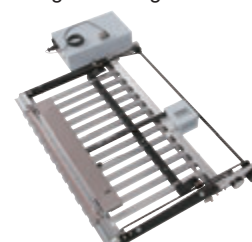

Sheet Width	Up to 738 mm or 29.06"
Sheet Weight Range	Normal Paper 35 to 244 gsm

Blades

A wide variety of optional blades are available for various applications. (Blades in the photo are some examples.)

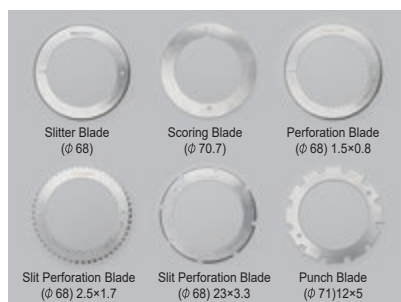

Unit : mm (Cut x Blank)

Name	Model	Description	Factory Option	764AKL	764AKLL	762KLS	746F	746S	744S
Supersonic Detector	SD-74F / SD-74R / SD-74P	Detects space between sheets for accurate double feed detection even with a solid black printed sheet.	No	*	*	Standard	Standard	Yes	Yes
Image Checker	-	A camera scans the printed image to identify any blank or misloaded sheets.	No	*	*	*	*	*	*
Barcode Reader	-	Barcode verification and misprint detection.	No	*	*	*	*	*	*
Feed Table Guide Bar	-	The guide bar helps to load the sheets to improve the operation. Only available for flat feeder FFU-76M.	No	* Only for FFU	* Only for FFU	No	No	No	No
Side Air on rear side	-	Additional side air to assist stable feeding. Only available for flat feeder FFU-74M.	No	* Only for FFU	* Only for FFU	*	No	No	No
Gluing Unit	CGU-K74 + CGU-50	Gluing gun and controller to produce glued booklet.	No	*	*	*	Yes	Yes	Yes
Front Perforation Unit	FP-74	Front perforation unit. Available only as factory option.	Yes	Yes	Yes	Yes	Yes	Yes	Yes
Skip Perforation Unit	-	Skip perforation unit. only available with FP-74.	No	*	*	*	*	*	*
Strip Trim Device	AF-ST6	Strip trimming after the parallel fold section for multiple-up jobs.	No	Yes	Yes	Yes	Yes	Yes	Yes
Edge Trim Device	AF-ET6	Edge trimming for the parallel fold section.	No	Yes	Yes	Yes	Yes	Yes	Yes
Punch Perforation Unit	AF-PP6	Punch perforation for 8 or 12 page signature for deep glue penetration when producing perfect bound book.	No	Yes	Yes	Yes	Yes	Yes	Yes
Strip Trim Device below 1st Knife	KT-ST6	Strip trimming after the cross fold section for multiple-up jobs.	No	No	No	No	Yes	Yes	Yes
Edge Trim Device below 1st Knife	KT-ET6	Enables to trim the edge of cross folded signatures.	No	No	No	No	*	Yes	Yes
Punch Perforation Unit below 1st Knife	KT-PP6	Punch perforation for 16-page signatures with cross knife unit connection.	No	No	No	Yes	Yes	Yes	Yes
	K1-PP7		No	Yes	Yes	No	No	No	No
Punch Perforation Unit below 2nd Knife	K2-PP7	Punch perforation for 32-page signatures with cross knife unit connection. Only available with MS-2K.	No	Yes	Yes	No	No	No	No
Perforation Unit below 2nd Knife	MS-2K	Slit perforation and scoring for 32-page signatures.	No	No	No	No	Yes	Yes	Yes
	-		No	Standard	Standard	No	No	No	No
Gate Fold Buckle	GFB-74	Gate fold buckle to produce closed gate fold application.	No	No	No	No	Yes	Yes	Yes
	GFB-76		No	Yes	Yes	No	No	No	No
Hard Urethane Roller for Parallel Fold	-	The wear-resistant hard urethane rollers. (segmented)	No	*	*	*	*	*	*
Deflector below Knife	KT-D74	Deflector which can be installed instead of buckle.	No	No	No	No	Selection	Selection	Selection
Buckle below Front Knife	KT-120	Maximum folding size is 120 mm. Manual type and automated type are available. This can be used on the front or rear side.	No	No	No	No	Selection	Selection	Selection
Buckle below Rear Knife	KT-250	Maximum folding size is 250 mm. Manual type and automated type are available. This can be used on the rear side only.	No	No	No	No	Selection	Selection	Selection

*Contact your local dealer about availability of connection.

764AKL

764AKLL

762KLS

746F

746S

744S

566F

566AKT

564AKT

406F/FL

406S/SL

AFC-56 Series

RFU-54 Round Pile Feeder Unit

The RFU-54 can be attached or detached without removing the standard flat pile feed table, making it quick and easy to interrupt long runs for short-run jobs. An error feed tray is equipped for continuous feeding operation.



Side Blowing Unit

The optional side are can be installed to assist constant feeding with for difficult to feed paper stocks.



SD-56 Supersonic Detector

Optional supersonic detector is available for double feed detection. This detects space between sheets for accurate double feed detection even with a solid black printed sheet.

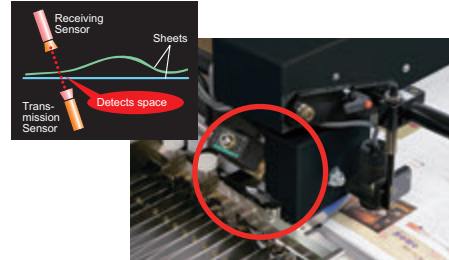

CGU-50 Gluing Unit

The gluing unit can produce 8-page or 12-page glued booklets and direct mail applications.

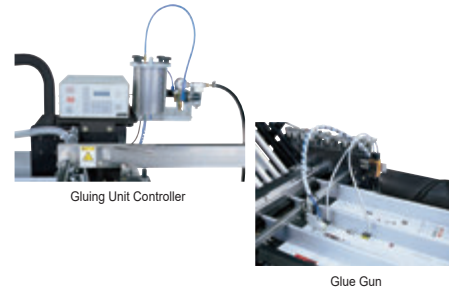

FP-56 Front Perforation Unit (Factory Option)

This unit permits perforating before folding. A hardened blade drum provides for high-precision micro perforation. Optional skip perforation (FSP-56) is available.



CGU-T56F Strip & Edge-Trim Device

Center strip trim and edge trim are available under the cross knife. Segmented rollers allows flexible adjustment of the cutting positions. (CGU-T56 is available for AFC-566AKT/564AKT.)



GFB-56 Gate Fold Buckle

The gate fold buckle can be set up quickly, with no special skill for precise, accurate closed gate folding.

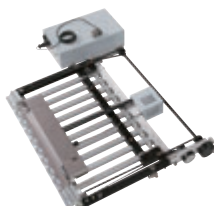

Sheet Width	Up to 558 mm or 21.965"
Sheet Weight Range	Normal Paper 35 to 244 gsm
Knife Folding Length	60 to 335 mm or 2.37" to 13.2"

Blades

A wide variety of optional blades are available for various applications. (Blades in the photo are examples.)



Unit : mm (Cut x Blank)

Name	Model	Description	Factory Option	566F	566AKT	564AKT
Round Pile Feeder Unit	RFU-54	Mobile round pile feeder.	No	Yes	Yes	Yes
Extension Table	LT-56	Enables to load sheets up to 1,100 mm (43.3") long.	No	No	Yes	Yes
	LT-56F		Yes	Yes	No	No
Supersonic Detector	SD-56/SD-56C	Detects space between sheets for accurate double feed detection even with a solid black printed sheet.	No	Standard	Yes	Yes
Side Blowing Unit	-	Side blowing assist air for stable feeding.	No	Standard	*	*
Image Checker	-	A camera scans the printed image to identify any blank or misloaded sheets.	No	*	*	*
Barcode Reader	-	Barcode scanning at resistor table for higher security control.	No	*	*	*
Ionizer	-	The ionizer reduces the static on the paper to minimize static related feed/folding issues.	No	*	*	*
Gluing Unit	CGU-K56+C-GU-50	Gluing gun and controller to produce glued booklet.	No	Yes	Yes	Yes
Front Perforation Unit	FP-56 *1	Front perforation unit. Only available as factory option.	Yes	Yes	Yes	Yes
Skip Perforation Unit	JM-AFC	Skip perforation unit. only available with FP-56.	No	*	*	*
Strip Trim Device	AF-ST5/AF-ST5N	Strip trimming after the parallel fold section for multiple jobs.	No	Yes	Yes	Yes
Edge Trim Device	AF-ET5/AF-ET5N	Edge trimming for the parallel fold section.	No	Yes	Yes	Yes
Punch Perforation Unit	AF-PP5	Punch perforation for 8 or 12 page signature for deep glue penetration when producing perfect bound book.	No	Yes	Yes	Yes
Punch Perforation Unit	AF-PP5N		No	Yes	Yes	Yes
Strip & Edge Trim Device below Knife	CGU-T56F	Strip and edge trimming for 8-page or 12-page signatures.	No	Yes	No	No
	CGU-T56		No	No	Yes	Yes
Edge Trim Device below Knife	CGU-T56FN	Edge trimming for 8-page or 12-page signatures.	No	Yes	No	No
	CGU-T56N		No	No	Yes	Yes
Punch Perforation Unit below 1st Knife	KT-PP56 *2	Punch perforation for 16-page signatures with cross knife unit connection.	No	Yes	Yes	Yes
Alignment Detector	-	Alignment detection on register conveyor.	No	No	No	No
Scoring Navigator	AF-SN56	The scoring position can be set easily according to the selected fold patterns and sizes.	No	No	No	No
Gate Fold Buckle	GFB-56	Gate fold buckle to produce closed gate fold application.	No	Yes	Yes	Yes
Hard Urethane Roller for Parallel Fold	-	The wear-resistant hard urethane rollers. (segmented)	No	*	*	*
Sound-Proof Cover (Full Cover)	AF-FCV566	The sound proof cover achieves quiet and safe operation.	Yes	Standard	AF-FCV566 Yes	No
Sound -Proof Cover (Upper Cover)	AF-UCV564	The sound proof cover achieves quiet and safe operation. This cove is available only for the buckle chute section.	Yes	No	No	AF-UCV564 Yes
Flat Deflector (Parallel)	-	The flat type deflector. Replaces the parallel folding buckle.	No	Yes	Yes	Yes
Flat Deflector (Below Knife)	-	The flat type deflector. Replaces the buckle below knife.	No	Yes	Yes	Yes

*Contact your local dealer about availability of connection.

*1 FP-56T for the T-564F

*2 he additional CGU-T56 is required to install.

764AKL

764AKLL

762KLS

746F

746S

744S

566F

566AKT

564AKT

406F/FL

406S/SL

AF-406 Series

Ultrasonic Sensor

The optional ultrasonic sensor can be used as the double feed detection sensor. This detects the space between sheets for accurate double feed detection.



Water Scoring Unit

The water scoring unit applies the water (mixed with alcohol) along the fold line at the register table. This enables the fold edge to be tightly pressed to improve the fold accuracy and quality. The fold rollers on the folder are rust-proof.



GFB-40 Gate Fold Buckle

The gate fold buckle can be set up quickly, with no special skill for precise, accurate closed-gate folding.



Sheet Size	Max. 400 mm, Min. 50 mm
Buckle Fold Length	Max. 175 mm, Min. 25 mm

AD-40S Alignment Detector

This detects the unfolded signatures or transport error to prevent the sheet jam.



Barcode Reader

High performance barcode reader, reads and compare the code to avoid error.

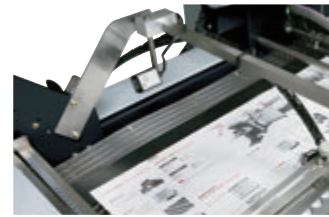

Available Codes	Most major codes are available.
-----------------	---------------------------------

LB-40S Long Buckle Chute

The maximum length of the fold is 430 mm / 13.78".

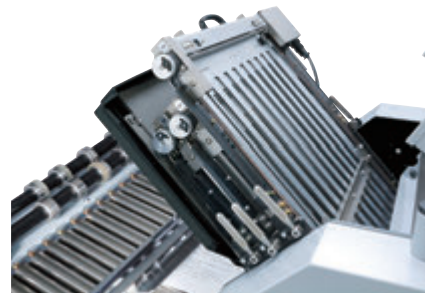

RB-40 Reversing Buckle

Provides versatility in folding pattern and imposition by reversing the sheet direction.



Sheet Size	1st Station : Max.400 mm, Min.75 mm 2nd Station : Max.400 mm, Min.50 mm
Sheet Weight Range	Max.220 mm, Min.30 mm

SN-40S Scoring Navigator

The scoring position can be adjusted by unit of 0.1 mm using the scoring navigator. This navigator also can read the scoring position and that position can be saved as a memory.

(The scoring navigator can be installed to the AF-406S/SL with the factory option.)

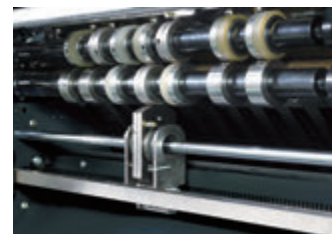

AF-ST4S Strip Trim Unit

Strip trimming in the parallel fold section can be performed using slitters for multiple-up jobs. The stripped width can be adjusted. (3 mm to 10 mm at 1 mm intervals)



Blades

A wide variety of optional blades are available for various applications. (Blades in the photo are examples.)



Unit : mm (Cut x Blank)

FABOX-40S Interface Unit

Interface unit to connect T-406A with AF-406F/FL and AF-406S/SL.



Name	Model	Description	Factory Option	406F/FL	406S/SL
Ultrasonic Sensor	SD-40S	This detects the space between sheets for accurate double feed detection.	No	Standard	Yes
Extension Table	LT-40S	The extension table allows to feed the sheet up to 900 mm / 35.5" long.	No	Yes	Yes
Image Checker	-	A camera scans the printed image to prevent human error such as mis-loading.	No	*	*
Barcode Reader	BR-40S	The barcode detects the errors such as misplaced page or blank page.	No	Yes	Yes
Long Buckle Chute	LB-40S	The maximum length of the fold is 430 mm / 13.78".	Yes	Yes	Yes
Strip Trim Unit	AF-ST4S	Strip trimming in the parallel fold section can be performed using slitters for multiple-up jobs.	No	Yes	Yes
Edge Trim Unit	AF-ET4S	The edge of parallel folded signature can be trimmed.	No	Yes	Yes
Scoring Navigator	SN-40S	Enables easy scoring position adjustment.	Yes	Yes	*
Alignment Detector	AD-40S	Alignment detection on resistor conveyor.	No	Yes	Yes
Water Scoring Unit	-	Water scoring to achieve tighter fold quality.	No	*	*
Gate Fold Buckle	GFB-40	Gate fold buckle to produce closed gate fold application.	No	Yes	Yes
Reversing Buckle	RB-40	Provide versatility in folding pattern and imposition by reversing the sheet direction.	No	Yes	Yes
Interface Unit	FABOX-40S	Interface unit to connect T-406A with AF-406F/FL and AF-406S/SL.	No	Yes	Yes

*Contact your local dealer about availability of connection.

764AKL

764AKLL

762KLS

746F

746S

744S

566F

566AKT

564AKT

406F/FL

406S/SL

Delivery Section

PST-66 / PST-44 / PST-44L Press Stacker

Newly designed presser stacker enables the production of crisp tight folded signatures. Tightly folded signatures are produced with a 2 step pressing mechanism. The 1st step removes the air from the folded signature and the 2nd tightens the fold. The presser stacker can be operated from the folder for efficient operation. This system can also be used as a booklet press to produce tighter folded booklets.

PST-66

Specially coated press rollers. Up to 660 mm / 26" width sheets can be received.



PST-66

PST-44/PST-44L

Two PST-44 models are available.

PST-44 is the standard model with space saving design. PST-44L is equipped with a longer delivery conveyor for longer run production. Up to 44 mm / 17.3" sheets can be received.



PST-44

Maximum Signature Width	With Off-set delivery: 660 mm or 25.98" Without Off-set delivery: 690 mm or 27.16"
Delivery Belt Length	800 mm or 31.5"
Voltage/Frequency	3-phase 200 to 220 V, 50 or 60 Hz Single Phase 220 to 240 V, 50 or 60 Hz
Machine Dimensions	W2,145× D1,159× H1,359 mm or W84.5" x D45.7" x H53.6"

Maximum Signature Width	With Off-set delivery : 440 mm or 17.32" Without Off-set delivery : 470 mm or 18.50"
Delivery Belt Length	PST-44 : 500 mm or 19.69", PST-44L : 800 mm or 31.5"
Voltage/Frequency	3-phase 200 to 220 V, 50 or 60 Hz Single Phase 220 to 240 V, 50 or 60 Hz
Machine Dimensions	PST-44 : W1,845 x D980 x H1,359 mm or W72.7" x D38.6" x H53.6" PST-44L : W2,145 x D980 x H1,359 mm or W84.5" x D38.6" x H53.6"

MKU-54T Mobile Knife Fold Unit

The MKU-54T is a mobile knife unit equipped with fold plates below the knife. It is capable of a letter fold after 8-page cross fold.

Signature Size	 Width x Length Max. 538 x 350 mm or 21.1" x 13.7" Min. 165 x 80 mm or 6.5" x 3.2"
Max. Folding Thickness	Max. 0.6 mm or 0.024" Booklet of 12 pages [81gsm] , Booklet of 16 pages [64gsm]
Sheet Weight Range	Uncoated Paper 35 to 244 gsm
Buckle Fold Length	60 to 150 mm or 2.36" to 5.90"(Manual Setting)
Voltage/Frequency	Single Phase 208 to 240 V, 50 or 60 Hz
Machine Dimensions	W860× D1,180 × H1,280mm or W33.9" x D46.5" x H50.4"



Name	Model	Description
Press Stacker	PST-66	Up to 660 mm / 26" width sheets can be received. 1.2 tons of pressure can be applied for tighter fold quality.
Press Stacker	PST-44 / PST-44L	Up to 440 mm / 17.3" width sheets can be received. Two models are available depending on space requirements.
Mobile Knife Fold Unit	MKU-54T	Mobile knife unit with buckle under the knife.
Mobile Knife Fold Unit	MKU-38	Mobile knife unit for additional knife fold.
Connecting Conveyor	MKU-CU	Bridge conveyor between folder and MKU-38.
Press Stacker with Pile Delivery	PSX-56	Tightly pressed signatures are stacked and delivered at a comfortable height.
Press Stacker with Pile Delivery	PSX-56R	Tightly pressed signatures are stacked and delivered at a comfortable height. The PSX-56R is for opposite delivery direction.
Delivery Conveyor	LCV-76	Conveyor for the AF-762KLS / 762KL.
Hook Conveyor	HCV-76	Conveyor for the AF-762KLS.
Long Conveyor	LCV-54	1.3 m long conveyor supports the efficient production.
Standing Delivery Unit	ED-40S	Standing delivery for easy handling and packaging.
Bridge Conveyor	BG-56	Transfer conveyor between first station and second station.

*Contact your local dealer about availability of connection.

*1 The conveyor equivalent to the LCV-76 is provided as standard equipment.

MKU-38 Mobile Knife Fold Unit

The MKU-38 can be connected with various folders as an additional knife unit, A wide range of applications are covered with a sheet size of 90 mm / 3.54" to 380 mm / 14.96".

*Depending on delivery direction of MKU-38, LCV-54 and SCV-406 cannot be connected.
Please consult with sales minimizes or eliminates static issues with light and sensitive stocks.
representative for detail information.

Signature Size		Width x Length Max. 380 x 280 mm or 14.9" x 11.0" Min. 90 x 20 mm or 3.6" x 0.8"
Max. Folding Thickness	Up to 2.3 mm or 0.09" thickness of folded sheet	
Sheet Weight Range	Uncoated Paper 35 to 210 gsm	
Voltage/Frequency	Single Phase 200 to 240 V, 50 or 60 Hz	
Machine Dimensions	W685 x D858 x H1,283.5 mm or W27.0" x D33.8" x H50.6"	



PSX-56/56R Press Stacker with Pile Delivery

Stacked signatures or booklets are delivered to a comfortable height for easy off-loading and handling. Applications can be stacked 1-up, 2-up or 3-up for efficient production. Rigid, large diameter rollers apply 1.2 tons of pressure for crisp, tight and flat folds.

Signature Size		Width x Length Max. 546 x 330 mm or 21.49" x 12.99" Min. 128 x 92 mm or 5.04" x 3.63"
Production Speed	Max. 900 stacks per hour (With continuous motion of the pushers)	
Voltage/Frequency	3-phase 200 to 220 V, 50 or 60 Hz Single Phase 200 to 240 V, 50 or 60 Hz	
Machine Dimensions	W2,120 x D2,280 x H1,080 mm or W83.5" x D89.8" x H42.6"	



ED-40S Standing Delivery

Standing delivery stacker increases the efficiency for sheet packing. Batch kicking function allows accurate counting.

Signature Size	Max. Width 400 mm or 15.74" Length 150 mm or 5.90" Min. Width 30 mm or 1.19" Length 20 mm or 0.79"
Voltage/Frequency	Single Phase 200 to 240V, 50 or 60 Hz
Machine Dimensions	W982 x D624 x H1,153 mm or W38.7" x D24.6" x H45.4"

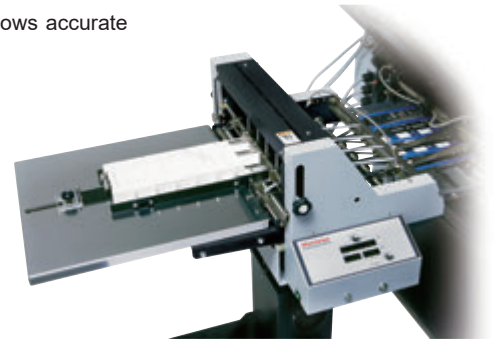

Factory Option	764AKL	764AKLL	762KLS	746F	746S	744S	566FKT	566AKT	564AKT	406F/FL	406S/SL
No	Yes	Yes	*	Yes	Yes	Yes	Yes	Yes	Yes	Yes	Yes
No	Yes	Yes	*	Yes	Yes	Yes	Yes	Yes	Yes	Yes	Yes
No	Yes	Yes	*	Yes	Yes	Yes	Yes	Yes	Yes	Yes	Yes
No	*	*	No	*	*	*	Yes	Yes	Yes	Yes	Yes
No	No	No	No	Yes	Yes	Yes	No	No	No	No	No
No	Yes	Yes	Yes	Yes	Yes	Yes	Yes	Yes	Yes	Yes	Yes
No	Yes	Yes	Yes	Yes	Yes	Yes	Yes	Yes	Yes	Yes	Yes
No	Yes	Yes	Yes	*1	*1	*1	No	No	No	No	No
No	No	No	Yes	No	No	No	No	No	No	No	No
No	No	No	No	No	No	No	Yes	Yes	Yes	Yes	Yes
No	No	No	No	No	No	No	Yes	Yes	Yes	Yes	Yes
No	No	No	No	No	No	No	No	No	No	No	No

764AKL

764AKLL

762KLS

746F

746S

744S

566F

566AKT

564AKT

406F/FL

406S/SL

Delivery Section for AF-406 Series

PR-40S Press Roller Unit

Strong and rigid press roller presses the folded sheets to form crisp tight folds. The press stacker can be used with the standing delivery unit ED-40. Tight folded sheets minimize shipping costs by reducing packaging.

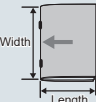
Signature Size 	Maximum Width 400 mm or 15.74" Minimum Width 30 mm or 1.19" Minimum Length 25 mm or 0.99"
Thickness of Folded Piece	Max. 3 mm or 0.12"
Voltage/Frequency	Single Phase 200 to 240 V, 50 or 60 Hz
Machine Dimensions	W791 x D657 x H1,066 mm or W31.2" x D25.9" x H42.0"

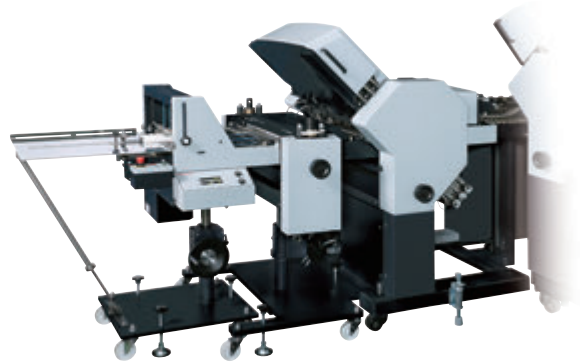

KTU-40 Mobile Knife Unit

A broad range of applications can be performed with the mobile knife unit. Both right angle and parallel direction can be processed depending on folding patterns.

*Optional conveyor KTU-PL is required for parallel configuration. Standing delivery is equipped as standard for easy handling of folded sheets. Buckle below knife can be set for greater application flexibility.

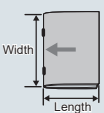

Signature Size 	Cross Knife Fold	Width x Length Max. 400 x 220 mm or 15.7" x 8.6" Min. 90 x 20 mm or 3.6" x 0.8"
	Paralell Knife Fold	Width x Length Max. 220 x 200 mm or 8.6" x 7.8" Min. 40 x 70 mm or 1.6" x 2.8"
	Vertical Stacking Section	Width x Length Max. 220 x 150 mm or 8.6" x 5.9" Min. 20 x 22 mm or 0.8" x 0.9"
Buckle Fold Length	20 to 110mm or 0.08 to 0.43" (Manual Setup)	
Voltage/Frequency	Single Phase 200 to 240 V, 50 or 60Hz	
Machine Dimensions	W1,140 x D1,620 x H1,180 mm or W44.9" x D63.8" x H46.5"	

KTU-KB Bypass Unit

This unit is used as a bypass. Replaces the fold roller below knife. Even the thick signatures can be transported smoothly by this bypass unit.

(This is the optional device for the KTU-40.)

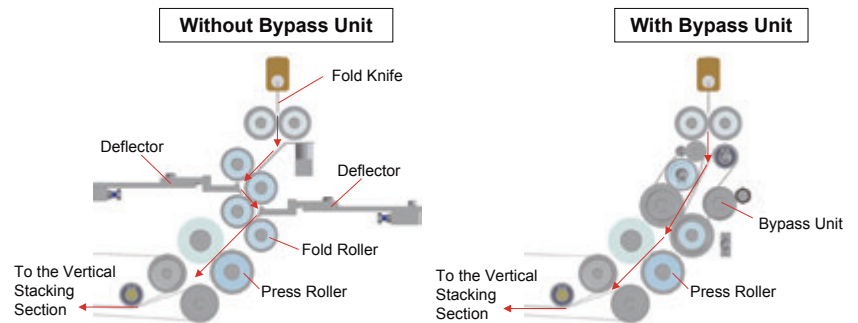

KTU-PL Parallel Fold Unit

The parallel fold can be performed using the in-feed unit and stopper.

(This is the optional device for the KTU-40.)



Name	Model	Description	Factory Option	406F/FL	406S/SL
Mobile Knife Unit	KTU-40	Mobile knife unit with standing delivery.	No	Yes	Yes
Parallel Fold Unit	KTU-PL	The parallel fold can be performed using the in-feed unit and stopper. (This is an optional device for the KTU-40.)	No	Yes	Yes
Bypass Unit	KTU-KB	This unit is used as a bypass. (This is an optional device for the KTU-40.)	No	Yes	Yes
Press Roller Unit	PR-40S	High performance press roller ensures crisp tight folds.	No	Yes	Yes
Short Conveyor	SCV-406	Space saving delivery conveyor.	No	*	*
Standing Delivery	ED-40S	Standing delivery unit improves the production efficiency for small sized signatures.	No	Yes	Yes

*Contact your local dealer about availability of connection.

764AKL

764AKL

762KLS

746F

746S

744S

566F

566AKT

564AKT

406F/FL

406S/SL



Change the **focus**

*The machine design and specifications are subject to change without any notice.

*Specifications may vary depending on the job, paper quality, environmental influences, and various other factors.

Please do a test run before starting production.

Distributed by

HORIZON INTERNATIONAL INC.

510 Kuze Ooyabu-cho, Minami-ku, Kyoto, 601-8206, Japan Phone : +81-(0)75-934-6700, Fax : +81-(0)75-934-6708, www.horizon.co.jp

201106/FolderOP/02E